

WPT2E33

Single, PNP, -30V, -3A, Power Transistor

Descriptions

The WPT2E33 is PNP bipolar power transistor with very low saturation voltage. This device is suitable for use in charging circuit and other power management. Standard Product WPT2E33 is Pb-free.

Features

- Ultra low collector-to-emitter saturation voltage
- High DC current gain >100
- 3A continue collector current
- Small package SOT-89-3L.

Applications

- Charging circuit
- Power regulator
- Other power management in portable equipments



SOT-89-3L

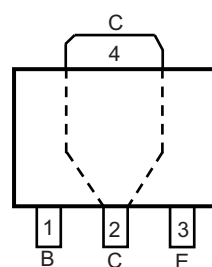

Pin configuration (Top view)

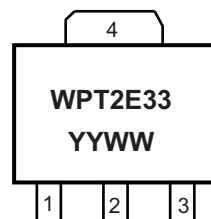

WPT2E33 = Device code
 YY = Year
 WW = Week
Marking

Order information

Device	Package	Shipping
WPT2E33-3/TR	SOT-89-3L	1000/Reel&Tape

Absolute maximum ratings

Parameter	Symbol	Value	Unit
Collector-emitter voltage	V_{CEO}	-30	V
Collector-base voltage	V_{CBO}	-30	V
Emitter-base voltage	V_{EBO}	-6	V
Continues collector current ^a	I_C	-3	A
Continues collector current ^b		-2	A
Pulse collector current ^c	I_{CM}	-6	A
Power dissipation ^a	P_D	3.0	W
Power dissipation ^b		1.5	W
Junction Temperature	T_J	150	°C
Lead Temperature	T_L	260	°C
Storage Temperature Range	T_{stg}	-55~155	°C

a Surface mounted on FR-4 Board using 1 square inch pad size, 1oz copper

b Surface mounted on FR-4 board using minimum pad size, 1oz copper

c Pulse width=300 μ s, Duty Cycle<2%

Electronics Characteristics (Ta=25°C, unless otherwise noted)

Parameter	Symbol	Test Conditions	Min.	Typ.	Max.	Unit
Collector-emitter breakdown voltage	BV_{CEO}	$I_C=-10mA, I_B=0mA$	-30			V
Collector-base breakdown voltage	BV_{CBO}	$I_C=-1mA, I_E=0mA$	-30			V
Emitter-base breakdown voltage	BV_{EBO}	$I_E=-100\mu A, I_C=0mA$	-6			V
Collector cutoff current	I_{CBO}	$V_{CB}=-30V$			-100	nA
Emitter cutoff current	I_{EBO}	$V_{EB}=-5V$			-100	nA
Collector-emitter saturation voltage ^c	$V_{CE(sat)}$	$I_C=-2A, I_B=-200mA$		-0.2	-0.4	V
Base-emitter saturation voltage ^c	$V_{BE(sat)}$	$I_C=-2A, I_B=-200mA$		-1.0	-1.5	V
Base-emitter forward voltage	$V_{BE(on)}$	$I_C=-0.5A, V_{CE}=-2V$		-0.7	-1.0	V
DC current gain ^c	h_{FE}	$I_C=-1A, V_{CE}=-2V$	100		300	

Typical Characteristics (Ta=25°C, unless otherwise noted)

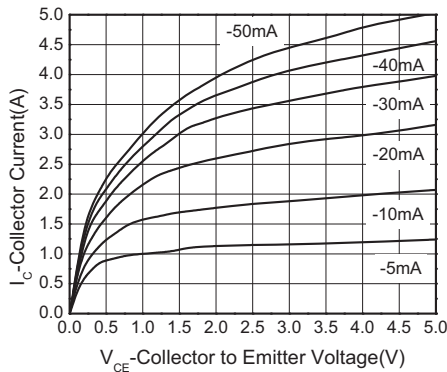

Output characteristics

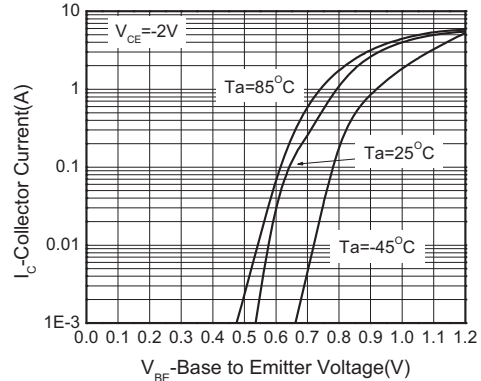

Transfer characteristics

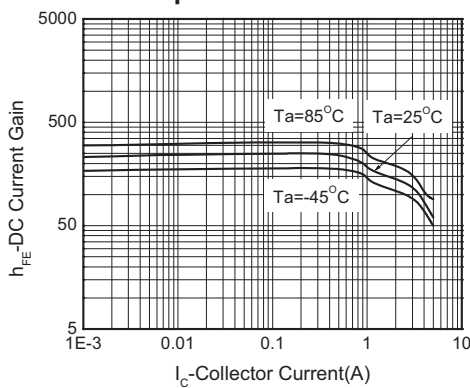

DC current gain

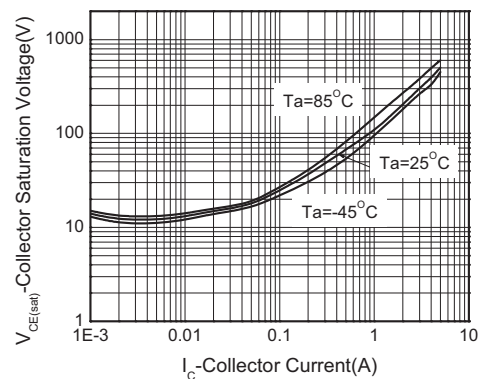

C-E saturation voltage vs. Collector current

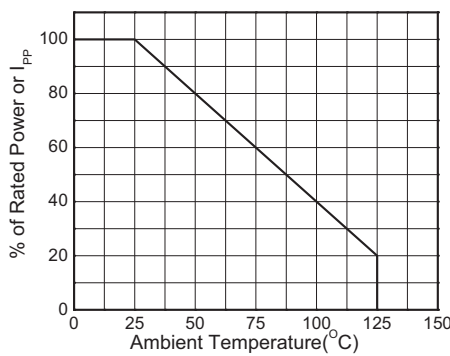

Power Derating

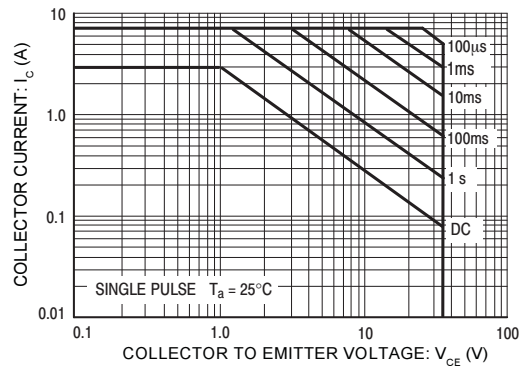

Safe operating area

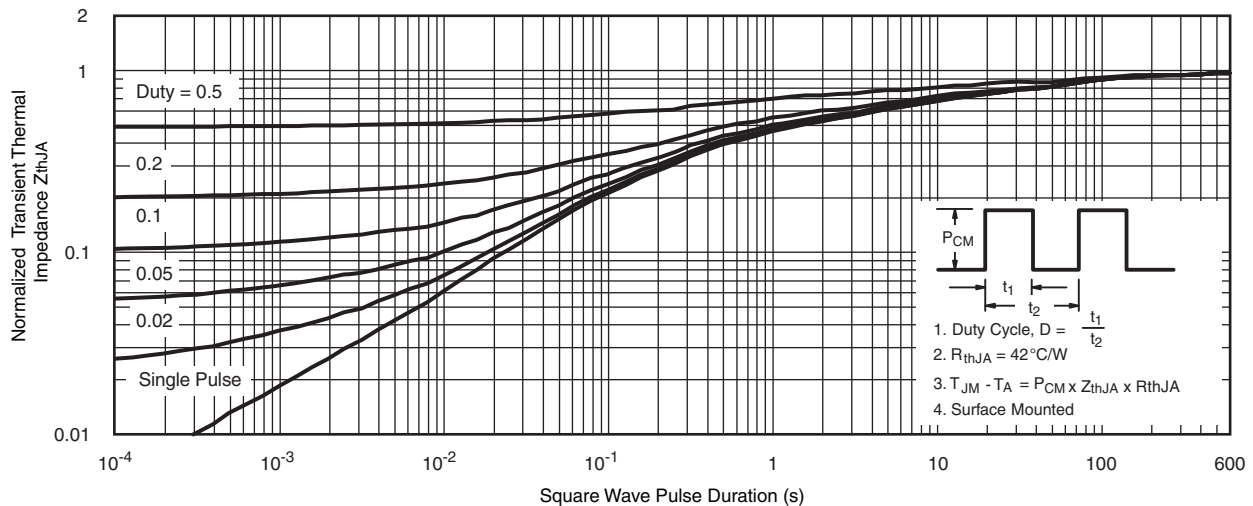

Transient thermal response (Junction-to-Ambient)

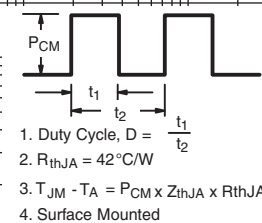

1. Duty Cycle, $D = \frac{t_1}{t_2}$
2. $R_{thJA} = 42^\circ\text{C/W}$
3. $T_{JM} - T_A = P_{CM} \times Z_{thJA} \times R_{thJA}$
4. Surface Mounted

Package outline dimensions

SOT-89-3L

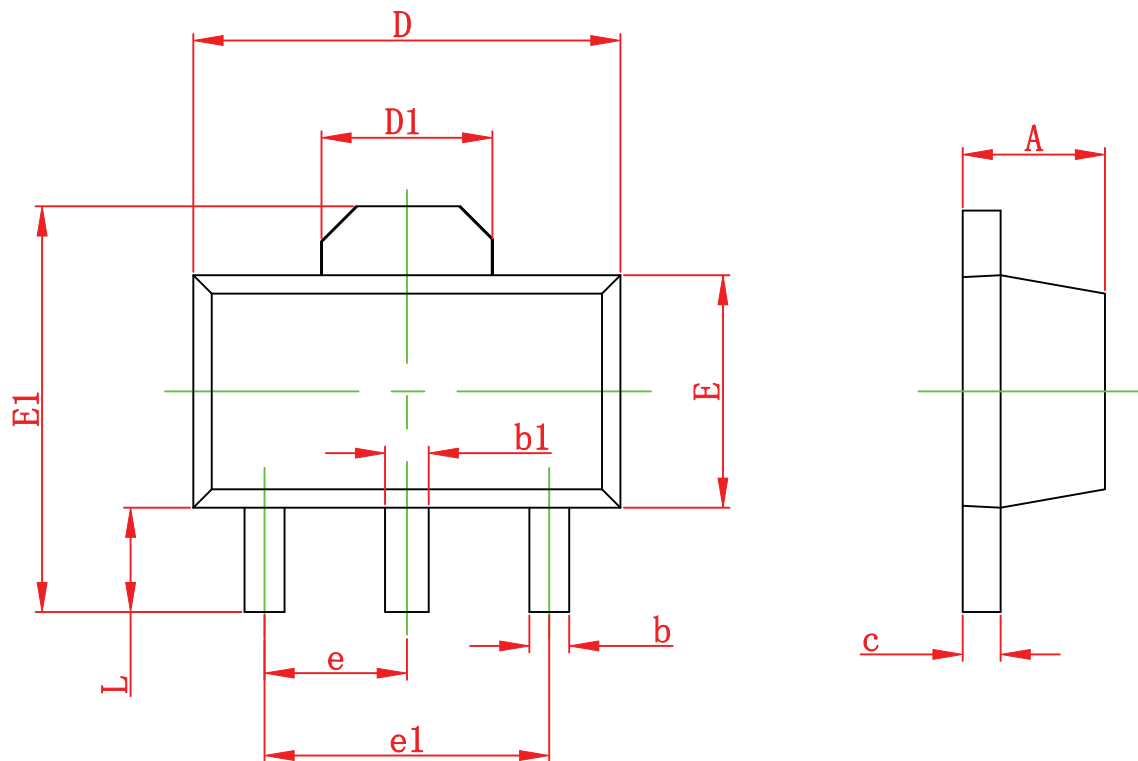

Symbol	Dimensions in Millimeters	
	Min.	Max.
A	1.400	1.600
b	0.320	0.520
b1	0.400	0.580
c	0.350	0.440
D	4.400	4.600
D1	1.550 Ref.	
E	2.300	2.600
E1	3.940	4.250
e	1.500 Typ.	
e1	3.000 Typ.	
L	0.900	1.200